

VASCA-DOCCIA TERMOSTATICO

CODICE FINITURA €

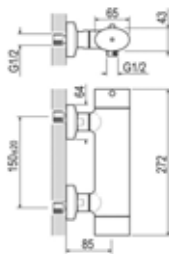

FIRB02527 FIRB02538

Miscelatore termostatico per doccia esterno, fermo di sicurezza 38°.

Thermostatic wall mounted shower mixer, safety lock at 38°.

Mitigeur thermostatique douche extérieur avec fermeture sécurité à 38°.

Brausen-Thermostatmischer Aufputz, Sicherheitssperre 38°.

Mezclador termostático exterior para ducha, fermo de seguridad 38°.



FFTH38529	05	320,00
FFTH38529	55	480,00



FIRB02527 FIRB02538

Miscelatore termostatico per doccia esterno, fermo di sicurezza 38°, limitatore di portata risparmio acqua ed energia 50%.

Thermostatic wall mounted shower mixer, safety lock at 38°, flow limit restrictor 50% save water and energy.

Mitigeur thermostatique pour douche extérieur, fermeture de sécurité à 38°, limiteur de débit épargne d'eau et énergie 50%.

Brausen Thermostatmischer Aufputz, Sicherheitssperre 38°, Durchflussbegrenzer 50% Sparwasser und -Energie.

Mezclador termostático exterior para ducha, fermo de seguridad 38°, limitador de caudal ahorro de agua y energía 50%.



FFTH38532	05	330,00
FFTH38532	55	495,00



FIRB02527 FIRB02538

Miscelatore termostatico per vasca esterno, fermo di sicurezza a 38°, deviatore automatico, aeratore 28x1.

Thermostatic wall mounted bath mixer, safety lock at 38°, automatic diverter, aerator 28x1.

Mitigeur thermostatique pour bain extérieur, avec fermeture de sécurité à 38°, inverseur automatique, aérateur 28x1.

Wannen-Thermostatmischer Aufputz, Sicherheitssperre 38°, automatischer Umsteller, Strahlregler 28x1.

Mezclador termostático exterior para baño, fermo de seguridad 38°, desviador automático, aireador 28x1.



FATH38499	05	430,00
FATH38499	55	645,00

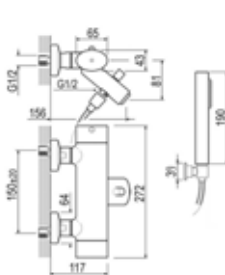

FIRB02527 FIRB02538

Miscelatore termostatico per vasca esterno, fermo di sicurezza a 38°, deviatore automatico, aeratore 28x1, doccia, supporto fisso, flessibile Cromalux 150 cm.

Thermostatic wall mounted bath mixer, safety lock at 38°, automatic diverter, aerator 28x1, handshower, fixed bracket, 150 cm flexible shower hose Cromalux.

Mitigeur thermostatique pour bain extérieur, fermeture de sécurité à 38°, inverseur automatique, aérateur 28x1, douche, support fixe, flexible Cromalux cm 150.

Wannen-Thermostatmischer Aufputz, Sicherheitssperre 38°, automatischer Umsteller, Strahlregler 28x1, Handbrause, fixer Brausehalter, Flexschlauch Cromalux 150 cm.

Mezclador termostático exterior para baño, fermo de seguridad 38°, desviador automático, aireador 28x1, ducha, soporte fijo, flex. Cromalux cm 150.

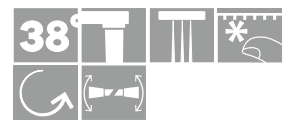

FATH38534	05	570,00
FATH38534	55	855,00

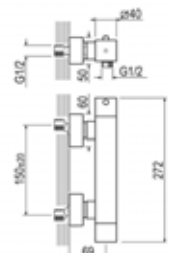

FIRB02527 FIRB02538

Miscelatore termostatico per doccia esterno, fermo di sicurezza a 38°.

Thermostatic wall mounted shower mixer, safety lock at 38°.

Mitigeur thermostatique pour douche extérieur, fermeture de sécurité 38°.

Brausen-Thermostatmischer Aufputz, Sicherheitssperre 38°.

Mezclador termostático exterior para ducha, fermo de seguridad 38°.



FFTH36529	05	385,00
FFTH36529	55	578,00

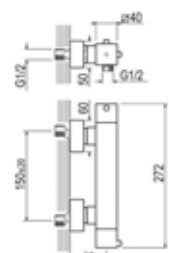

FIRB02527 FIRB02538

Miscelatore termostatico per doccia esterno, fermo di sicurezza a 38°, limitatore di portata risparmio acqua ed energia 50%.

Thermostatic wall mounted shower mixer, safety lock at 38°, flow control button (50% water and energy saving).

Mitigeur thermostatique pour douche extérieur, fermeture de sécurité 38°, limiteur de débit épargne d'eau et énergie 50%.

Brausen-Thermostatmischer Aufputz, Sicherheitssperre 38°, Durchflussbegrenzer für Wasser- und Energieeinsparung 50%.

Mezclador termostático exterior para ducha, fermo de seguridad 38°, limitador de caudal ahorro de agua y energía 50%.



FFTH36532	05	395,00
FFTH36532	55	593,00

VASCA-DOCCIA TERMOSTATICO

CODICE FINITURA €



Miscelatore termostatico per vasca esterno, fermo di sicurezza a 38°, deviatore automatico, aeratore 28x1.

FATH36499 05 510,00

FATH36499 55 765,00

Thermostatic wall mounted bath mixer, safety lock at 38°, automatic diverter, aerator 28x1.

Mitigeur thermostatique pour bain extérieur, fermeture de sécurité 38°, inverseur automatique, aérateur 28x1.

Wannen-Thermostatmischer Aufputz, Sicherheitssperre 38°, automatischer Umsteller, Strahlregler 28x1.

Mezclador termostático exterior para baño, fermo de seguridad 38°, desviador automático, aireador 28x1.



FIRB02527 FIRB02538

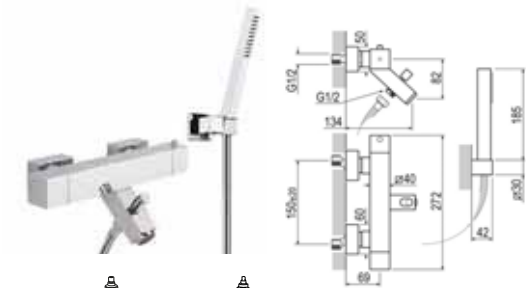

Miscelatore termostatico per vasca esterno, fermo di sicurezza 38°, deviatore automatico, aeratore 28x1, doccia, supporto, flessibile Cromalux 150 cm.

FATH36534 05 600,00

FATH36534 55 900,00

Thermostatic wall mounted bath mixer, safety lock at 38°, automatic diverter, aerator 28x1, handshower, bracket, 150 cm flexible shower hose Cromalux.

Mitigeur thermostatique pour bain extérieur, fermeture de sécurité 38°, inverseur automatique, aérateur 28x1, douche, support, flexible Cromalux 150 cm.

Wannen-Thermostatmischer Aufputz, Sicherheitssperre 38°, automatischer Umsteller, Strahlregler 28x1, Handbrause, Brausehalter, Flexschlauch Cromalux 150 cm.

Mezclador termostático exterior para baño, fermo de seguridad 38°, desviador automático, aireador 28x1, ducha, soporte, flex. Cromalux cm 150.



FIRB02527 FIRB02538



Miscelatore termostatico per doccia esterno, fermo di sicurezza 38°.

FFTH37529 05 230,00

Thermostatic wall mounted shower mixer, anti burns safety lock at 38°.

Mitigeur thermostatique douche extérieur, avec arrêt de sécurité à 38° antibûrûle.

Brausen-Thermostatmischer Aufputz, Sicherheitssperre 38° Anti-Verbrûhung.

Mezclador termostático exterior para ducha, seguro 38° antiquemadura.



FIRB02527 FIRB02538

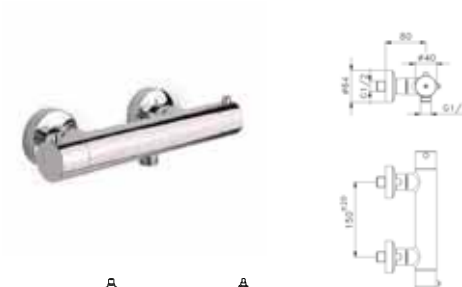

Miscelatore termostatico per doccia esterno, fermo di sicurezza a 38°, limitatore di portata risparmio acqua ed energia 50%.

FFTH37532 05 240,00

Thermostatic wall mounted shower mixer, safety lock at 38°, flow control button 50% water and energy saving.

Mitigeur thermostatique pour douche extérieur avec fermeture de sûreté 38°, limiteur de débit épargne d'eau et énergie 50%.

Brausen-Thermostatmischer Aufputz, Sicherheitssperre 38°, Durchflussbegrenzer für Wasser- und Energieeinsparung 50%.

Mezclador termostático exterior para ducha, con fermo de seguridad 38°, limitador de caudal ahorro de agua y energía 50%.



FIRB02527 FIRB02538

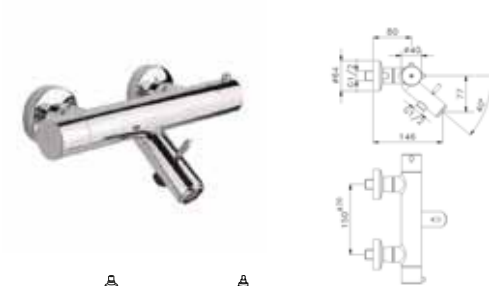

Miscelatore termostatico per vasca esterno, fermo di sicurezza a 38°, deviatore automatico, aeratore 28x1.

FATH37499 05 310,00

Thermostatic wall mounted bath mixer, safety lock at 38°, automatic diverter, aerator 28x1.

Mitigeur thermostatique pour bain extérieur avec fermeture de sécurité à 38°, inverseur automatique, aérateur 28x1.

Wannen-Thermostatmischer Aufputz, Sicherheitssperre 38°, automatischer Umsteller, Strahlregler 28x1.

Mezclador termostático exterior para baño, fermo de seguridad 38°, desviador automático, aireador 28x1.



FIRB02527 FIRB02538

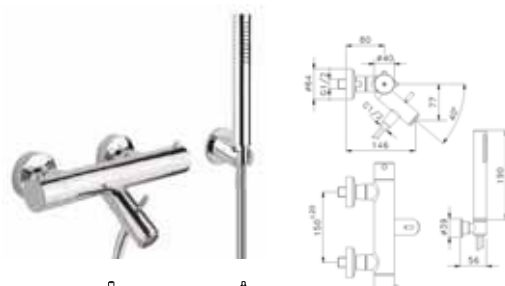

Miscelatore termostatico per vasca esterno, fermo di sicurezza a 38°, deviatore automatico, aeratore 28x1, doccia, supporto fisso, flessibile 150 cm.

FATH37534 05 395,00

Thermostatic wall mounted bath mixer, safety lock at 38°, automatic diverter, aerator 28x1, handshower, fixed bracket, 150 cm flexible shower hose.

Mitigeur thermostatique pour bain extérieur avec fermeture de sécurité à 38°, inverseur automatique, aérateur 28x1, douche, flexible 150 cm.

Wannen-Thermostatmischer Aufputz, Sicherheitssperre 38°, automatischer Umsteller, Strahlregler 28x1, Handbrause, fixer Brausehalter, Flexschlauch 150 cm.

Mezclador termostático exterior para baño, fermo de seguridad 38°, desviador automático, aireador 28x1, ducha, soporte fijo, flexible cm 150.



FIRB02527 FIRB02538

VASCA-DOCCIA TERMOSTATICO

CODICE FINITURA €

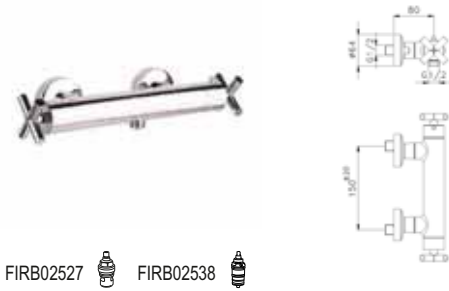

FIRB02527 FIRB02538

Miscelatore termostatico per doccia esterno, fermo di sicurezza a 38°.

FFTH47529 05 270,00

Thermostatic wall mounted shower mixer, safety lock at 38°.

FFTH47529 55 405,00

Mitigeur thermostatique pour douche extérieur, fermeture de sécurité 38°, raccord douche 1/2".

Brausen-Thermostatmischer Aufputz, Sicherheitssperre 38°.

Mezclador termostático exterior para ducha, fermo de seguridad 38°.

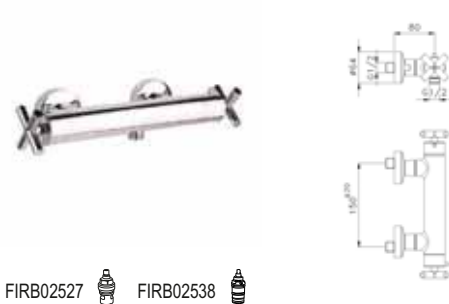

FIRB02527 FIRB02538

Miscelatore termostatico per doccia esterno, fermo di sicurezza a 38°, limitatore di portata risparmio acqua ed energia 50%.

FFTH47532 05 280,00

Thermostatic wall mounted shower mixer, safety lock at 38°, flow control button (50% water and energy saving).

FFTH47532 55 420,00

Mitigeur thermostatique pour douche extérieur, fermeture de sécurité 38°, douchette anticalcaire monojet, limiteur de débit épargne d'eau et énergie 50%.

Brausen-Thermostatmischer Aufputz, Sicherheitssperre 38°, Durchflussbegrenzer für Wasser- und Energieeinsparung 50%.

Mezclador termostático exterior para ducha, fermo de seguridad 38°, limitador de caudal ahorro de agua y energía 50%.



FIRB02527 FIRB02538

Miscelatore termostatico per vasca esterno, fermo di sicurezza a 38°, deviatore automatico, aeratore 28x1.

FATH47499 05 350,00

Thermostatic wall mounted bath mixer, safety lock at 38°, automatic diverter, aerator 28x1.

FATH47499 55 525,00

Mitigeur thermostatique extérieur pour bain, fermeture de sécurité 38°, inverseur automatique, aérateur 28x1.

Wannen-Thermostatmischer Aufputz, Sicherheitssperre 38°, automatischer Umsteller, Strahlregler 28x1.

Mezclador termostático exterior para baño, fermo de seguridad 38°, desviador automático, aireador 28x1.



FIRB02527 FIRB02538

Miscelatore termostatico per vasca esterno, fermo di sicurezza a 38°, deviatore automatico, aeratore 28x1, doccia, supporto fisso, flessibile 150 cm.

FATH47534 05 435,00

Thermostatic wall mounted bath mixer, safety lock at 38°, automatic diverter, aerator 28x1, handheld shower, fixed bracket, 150 cm flexible shower hose.

FATH47534 55 653,00

Mitigeur thermostatique extérieur pour bain, fermeture de sécurité à 38°, inverseur automatique, aérateur 28x1, douchette, support fix, flexible cm 150.

Wannen-Thermostatmischer Aufputz, Sicherheitssperre 38°, automatischer Umsteller, Strahlregler 28x1, Handbrause, fixer Brausehalter, Flexschlauch 150 cm.

Mezclador termostático exterior para baño, fermo de seguridad 38°, desviador automático, aireador 28x1, ducha, soporte fijo, flex. cm 150.

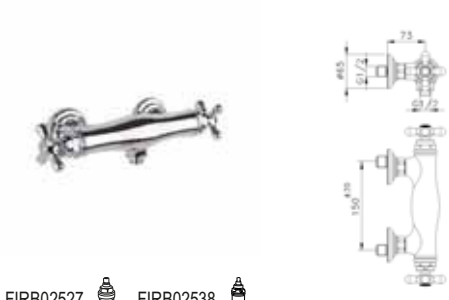

FIRB02527 FIRB02538

Miscelatore termostatico per doccia esterno, fermo di sicurezza 38°.

FFTH48529 05 292,00

Thermostatic wall mounted shower mixer, safety lock at 38°.

FFTH48529 TR 438,00

Mitigeur douche thermostatique extérieur, fermeture de sécurité 38°.

Brausen-Thermostatmischer Aufputz, Sicherheitssperre 38°.

Mezclador termostático exterior para ducha, fermo de seguridad 38°.



FIRB02527 FIRB02538

Miscelatore termostatico per vasca esterno, fermo di sicurezza a 38°, deviatore automatico, aeratore 28x1.

FATH48499 05 345,00

Thermostatic wall mounted bath mixer, safety lock at 38°, automatic diverter, aerator 28x1.

FATH48499 TR 518,00

Mitigeur thermostatique extérieur pour bain, fermeture de sécurité 38°, inverseur automatique, aérateur 28x1.

Wannen-Thermostatmischer Aufputz, Sicherheitssperre 38°, automatischer Umsteller, Strahlregler 28x1.

Mezclador termostático exterior para baño, fermo de seguridad 38°, desviador automático, aireador 28x1.



VASCA-DOCCIA TERMOSTATICO

CODICE FINITURA €

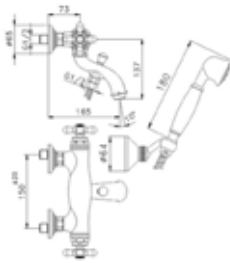

Miscelatore termostatico per vasca esterno, fermo di sicurezza a 38°, deviatore automatico, aeratore 28x1, doccia, flessibile 150 cm.

FATH48630 05 420,00

FATH48630 TR 630,00

Thermostatic wall mounted bath mixer, safety lock at 38°, automatic diverter, aerator 28x1, shower, 150 cm flexible shower hose.

Mitigeur thermostatique extérieur pour bain, fermeture de sécurité 38°, inverseur automatique, aérateur 28x1, douche, flexible cm 150.

Wannen-Thermostatmischer Aufputz, Sicherheitssperre 38°, automatischer Umsteller, Strahlregler 28x1, Handbrause, Flexschlauch 150 cm.

Mezclador termostático exterior para baño, fermo de seguridad 38°, desviador automático, aireador 28x1, ducha, flex. cm 150.



FIRB02527 FIRB02538



Miscelatore termostatico per doccia esterno, fermo di sicurezza 38°.

FFTH49529 05 287,00

FFTH49529 TR 431,00

Thermostatic wall mounted shower mixer, safety lock at 38°.

Mitigeur douche thermostatique extérieur, fermeture de sécurité 38°.

Brausen-Thermostatmischer Aufputz, Sicherheitssperre 38°.

Mezclador termostático exterior para ducha, fermo de seguridad 38°.



FIRB02527 FIRB02538

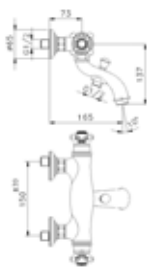

Miscelatore termostatico per vasca esterno, fermo di sicurezza a 38°, deviatore automatico, aeratore 28x1.

FATH49499 05 350,00

FATH49499 TR 525,00

Thermostatic wall mounted bath mixer, safety lock at 38°, automatic diverter, aerator 28x1.

Mitigeur thermostatique extérieur pour bain, fermeture de sécurité à 38°, inverseur automatique, aérateur 28x1.

Wannen-Thermostatmischer Aufputz, Sicherheitssperre 38°, automatischer Umsteller, Strahlregler 28x1.

Mezclador termostático exterior para baño, fermo de seguridad 38°, desviador automático, aireador 28x1.



FIRB02527 FIRB02538

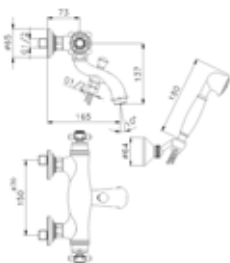

Miscelatore termostatico per vasca esterno, fermo di sicurezza a 38°, deviatore automatico, aeratore 28x1, doccia, flessibile 150 cm.

FATH49630 05 420,00

FATH49630 TR 630,00

Thermostatic wall mounted bath mixer, safety lock at 38°, automatic diverter, aerator 28x1, handshower, 150 cm flexible shower hose.

Mitigeur thermostatique extérieur pour bain, fermeture de sécurité à 38°, inverseur automatique, aérateur 28x1, douche, flexible cm 150.

Wannen-Thermostatmischer Aufputz, Sicherheitssperre 38°, automatischer Umsteller, Strahlregler 28x1, Handbrause, Flexschlauch 150 cm.

Mezclador termostático exterior para baño, fermo de seguridad 38°, desviador automático, aireador 28x1, ducha, flex. cm 150.



FIRB02527 FIRB02538

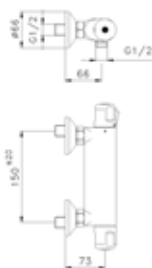

Miscelatore termostatico per doccia esterno, fermo di sicurezza a 38°.

FFTH00529 05 124,00

Thermostatic wall mounted shower mixer, safety lock at 38°.

Mitigeur thermostatique douche extérieur, fermeture de sécurité à 38°.

Brausen-Thermostatmischer Aufputz, Sicherheitssperre 38°.

Mezclador termostático exterior para ducha, fermo de seguridad 38°.



FIRB02506 FIRB02538

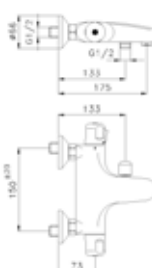

Miscelatore termostatico per vasca esterno, fermo di sicurezza a 38°, deviatore automatico, aeratore 28x1.

FATH00499 05 170,00

Thermostatic bath mixer, safety lock at 38°, automatic diverter, aerator 28x1.

Mitigeur thermostatique bain extérieur, fermeture de sécurité à 38°, inverseur automatique, aérateur 28x1.

Wannen-Thermostatmischer Aufputz, Sicherheitssperre 38°, automatischer Umsteller, Strahlregler 28x1.

Mezclador monomando exterior para baño, fermo de seguridad 38°, desviador automático, aireador 28x1.



FIRB02506 FIRB02538



FIRB02538 

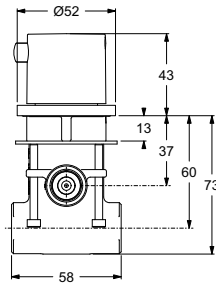

Miscelatore termostatico per pannello doccia, fermo di sicurezza 38°, completo di ghiera fissaggio.

FDTH37576 05 95,00

Thermostatic shower panel mixer, safety lock at 38°, complete of nut fixing.

Mitigeur thermostatique panneau de douche, fermeture de sécurité à 38°, avec écrou de fixation.

Brausen-Thermostatmischer Duschpaneel, Sicherheitssperre 38° mitt Fixierhülse.

Mezclador termostático para panel de ducha, fermo de seguridad a 38° con Fijación de la manga

